

ボード

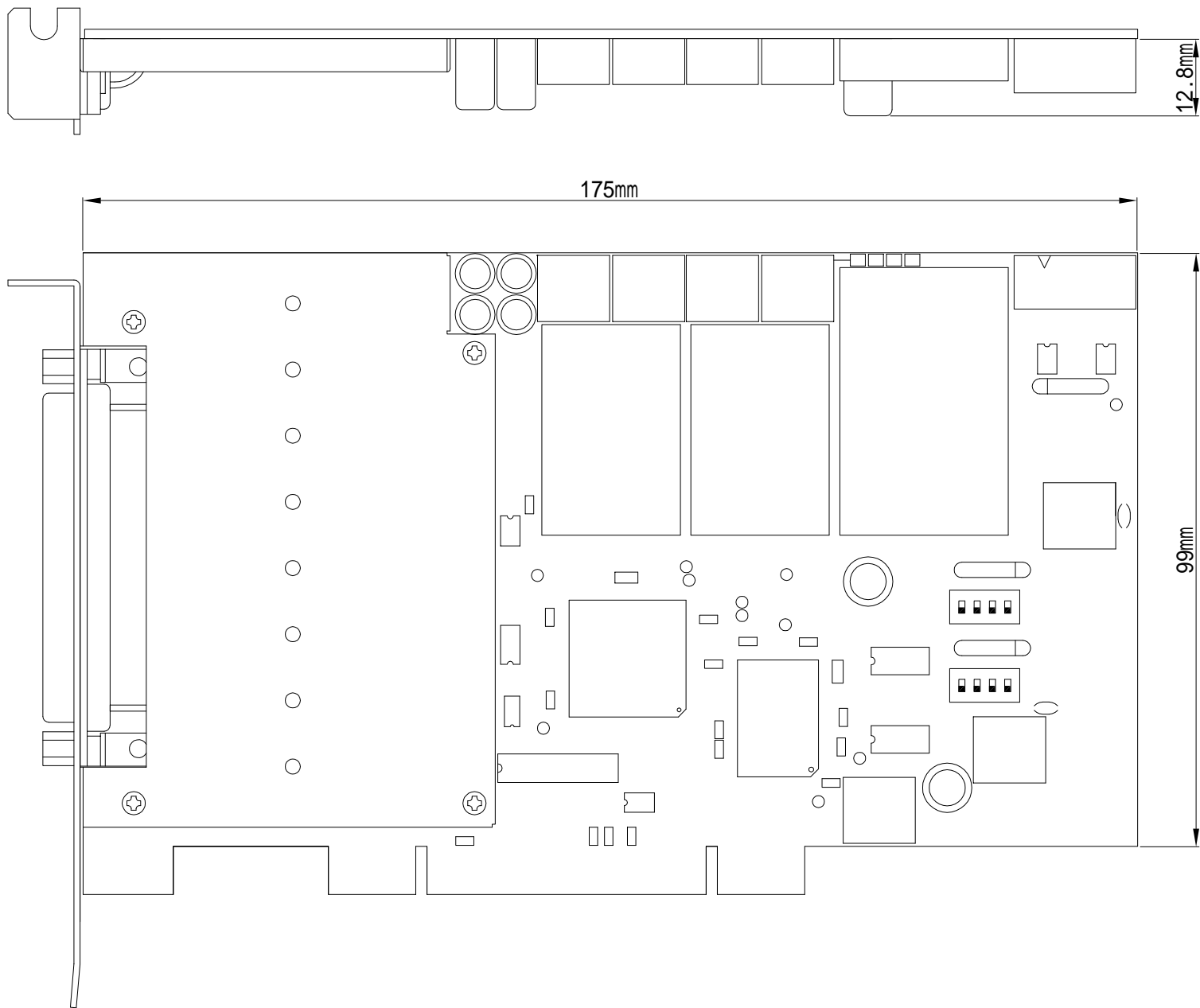

入力端子BOX

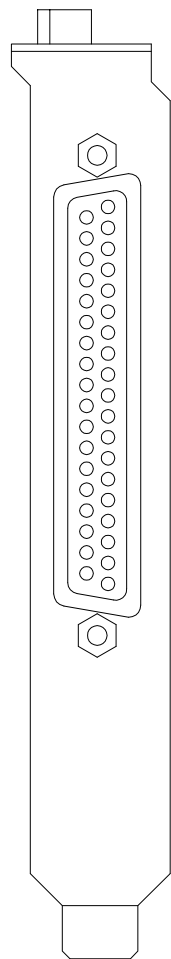
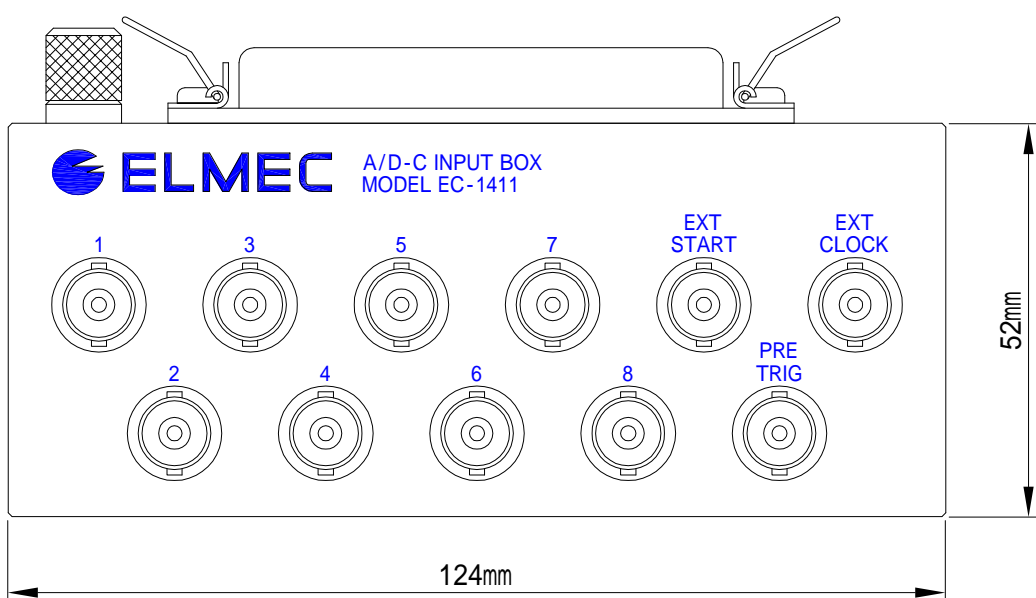
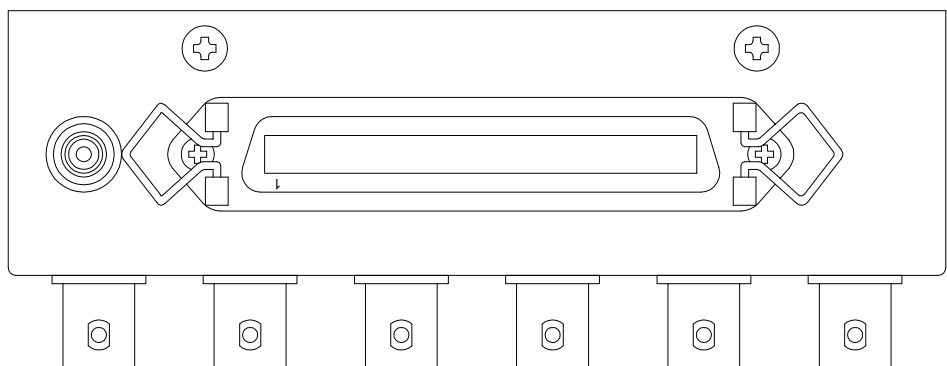

EC-1411D(差動入力タイプ)

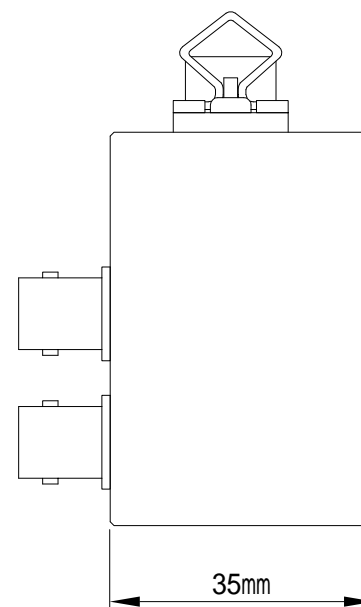

接続ケーブル

片側コネクタタイプ

D-Sub37Pオス

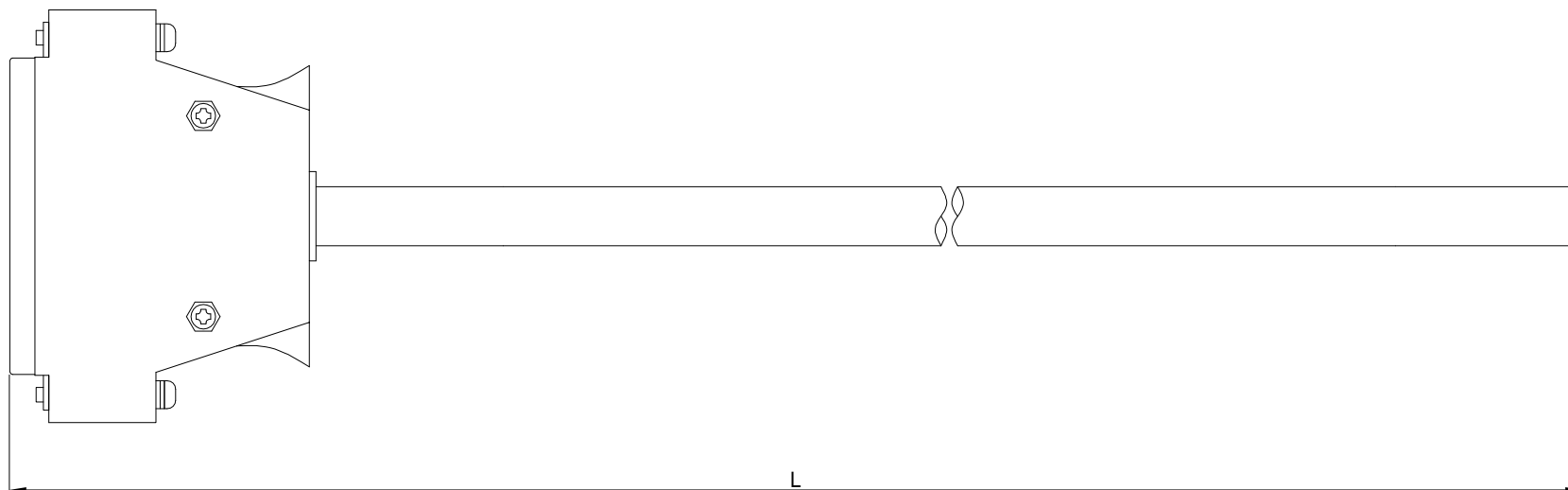

型番	ケーブル長(L)
EC-CBL-2396N-D-1	1m
EC-CBL-2396N-D-2	2m
EC-CBL-2396N-D-3	3m
EC-CBL-2396N-D-5	5m

両端コネクタタイプ

D-Sub37Pオス

アンフェ50Pオス

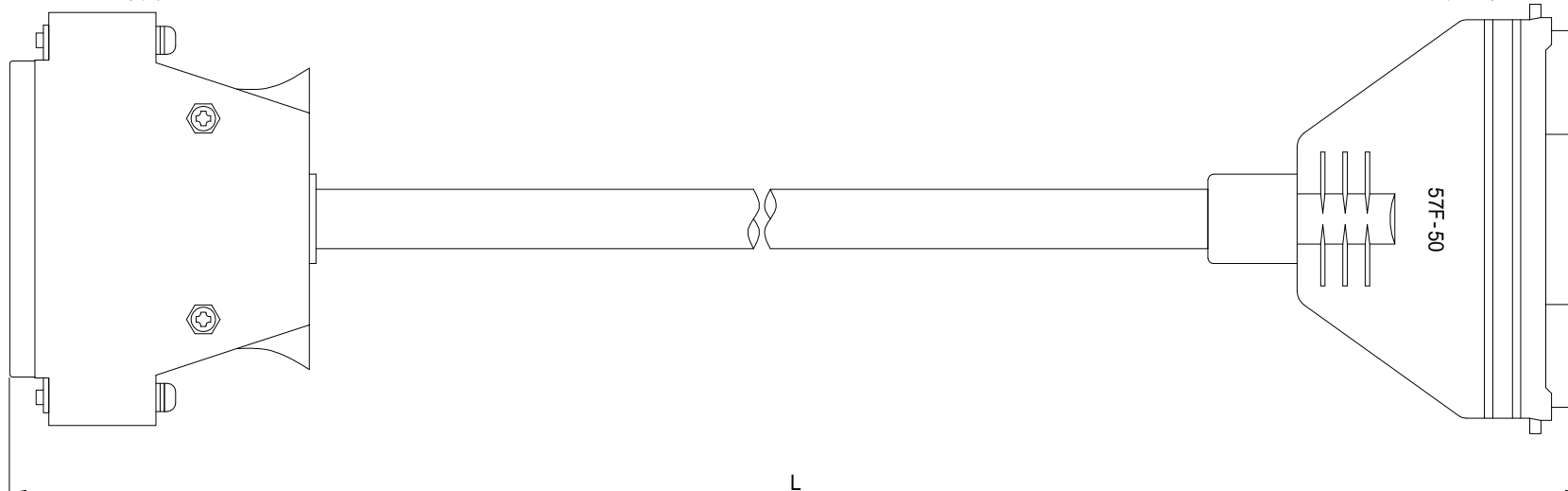

型番	ケーブル長(L)
EC-CBL-2396N-DAM-1	1m
EC-CBL-2396N-DAM-2	2m
EC-CBL-2396N-DAM-3	3m
EC-CBL-2396N-DAM-5	5m